

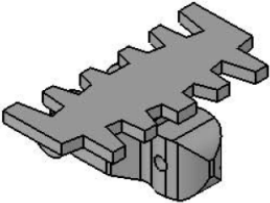

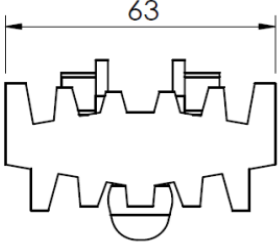

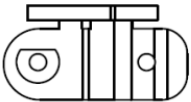

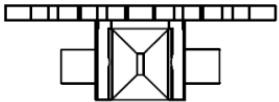

		Plain chain 平面鏈條		
		Chain	Link	<b>F45</b>
		FLTP 5	FLTL 63	<b>FT</b>
		FLTP 5C	n.a.	<b>FS</b>
		Ultra wear resist chain	超耐磨	<b>FL</b>
		FLTP 5E	FLTL 63E	<b>F65</b>
		Antistatic chain	抗靜電	<b>FM</b>
		F3903723	F3905377	<b>F85</b>
		PVDF		
		F3905376	F3905375	<b>FK</b>
		PBT		
		Steel top chain 不鏽鋼面鏈條		
		Chain	Link	<b>Spiral</b>
		FLTP 5TF	FLTL 63TF	<b>FW</b>
		Chain	Link	<b>IDX</b>
		FLTP 5F	FLTL 63F	
				

# FL

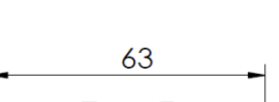
Pitch  
25.4mm

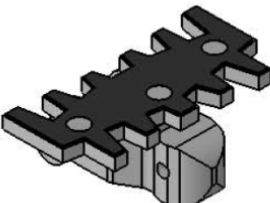
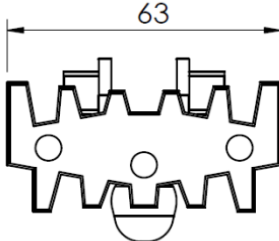
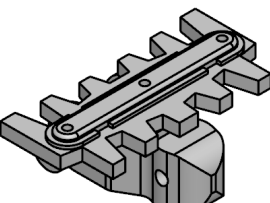
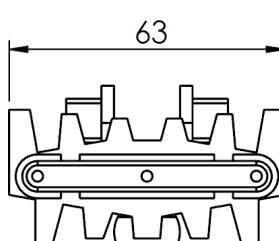
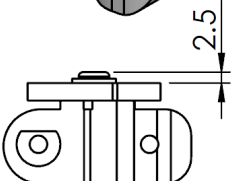
F45  
FT  
FS  
**FL**

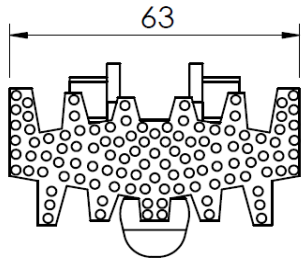
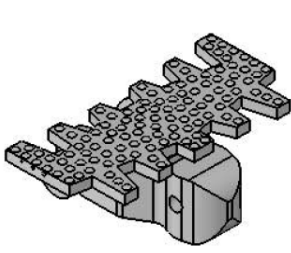

Plain chain w/ non-stick surface  
防黏平面鏈條

Chain	Link
F5058306	F5058304

F65  
FM

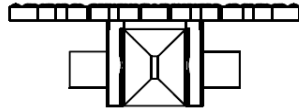
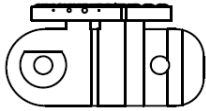

F85

FH

FK

FB

Spiral

FW

IDX

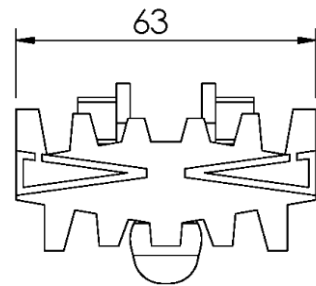
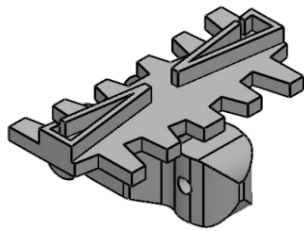

Cleated chain 檔板鏈條

Chain	Link	DIM.
FLTF 5X_A	FLTL 63X_A	
FLTF 5X4A	FLTL 63X4A	h=4
FLTF 5X5.5A	FLTL 63X5.5A	h=5.5

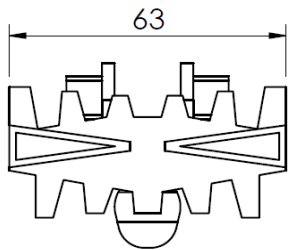
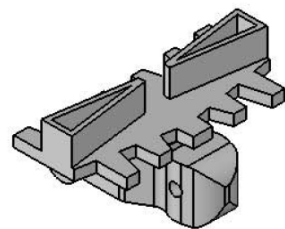
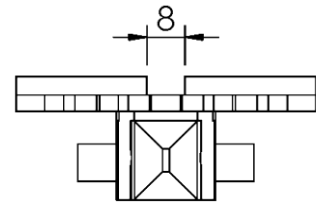
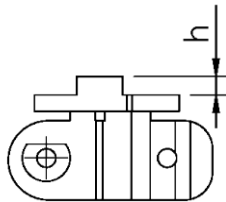

Cleated chain 檔板鏈條

Chain	Link	DIM.
FLTF 5X_A	FLTL 63X_A	
FLTF 5X9A	FLTL 63X9A	h=9
FLTF 5X12A	FLTL 63X12A	h=12
FLTF 5X15A	FLTL 63X15A	h=15
FLTF 5X17A	FLTL 63X17A	h=17
FLTF 5X30A	FLTL 63X30A	h=30
FLTF 5X40A	FLTL 63X40A	h=40

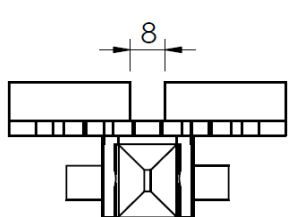
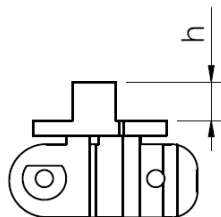

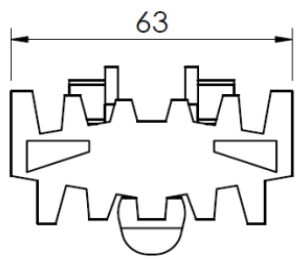
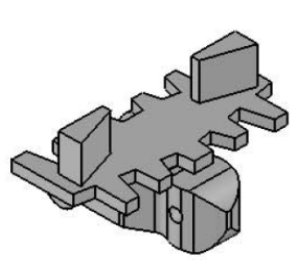

Cleated chain 檔板鏈條

Chain	Link
FLTF 5X12B	FLTL 63X12B

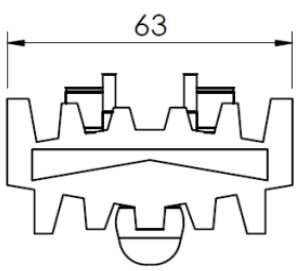
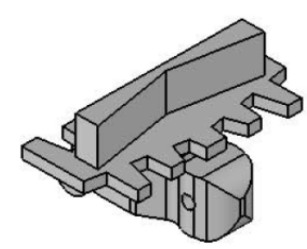
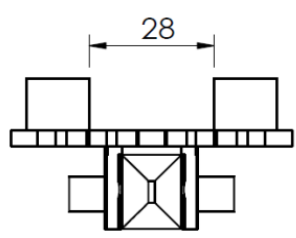
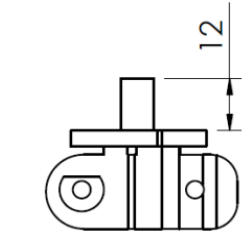

Cleated chain 檔板鏈條

Chain	Link	DIM.
FLTF 5X_C	FLTL 63X_C	
FLTF 5X12C	FLTL 63X12C	h=12
FLTF 5X15C	FLTL 63X15C	h=15
FLTF 5X30C	FLTL 63X30C	h=30

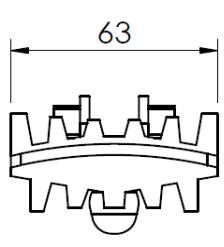
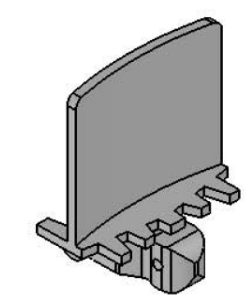
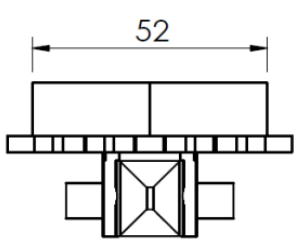
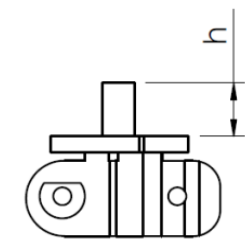

Cleated chain 檔板鏈條

Chain	Link
FLTF 5X55D	FLTL 63X55D

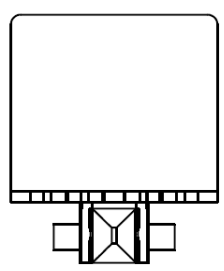
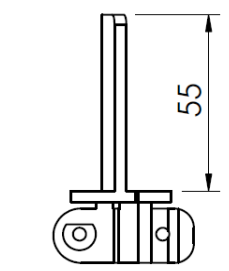

- F45
- FT
- FS
- FL**
- F65
- FM
- F85
- FH
- FK
- FB
- Spiral
- FW
- IDX

# FL

Pitch  
25.4mm

F45  
FT  
FS  
**FL**

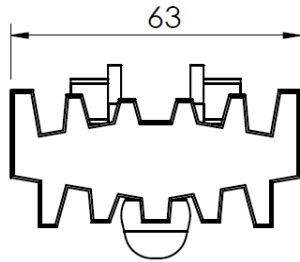
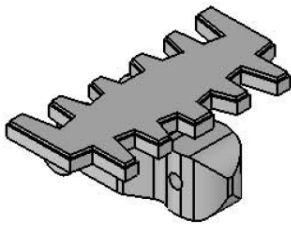

Flat top friction chain  
全阻滑鏈條

Chain	Link
FLTP 5FA	FLTL 63FA

F65  
FM  
F85

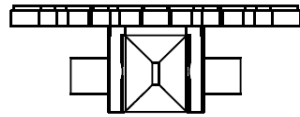
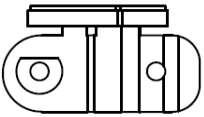

FH  
FK  
FB  
Spiral  
FW  
IDX

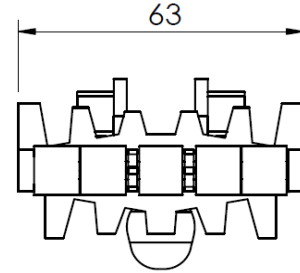
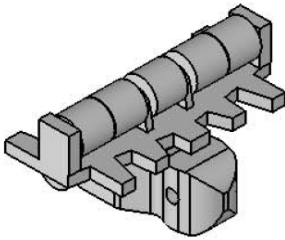

Roller top chain 滾珠鏈條

Chain	Link
FLTR 5	FLTL 63R

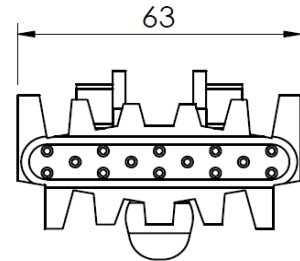
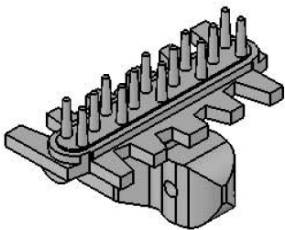
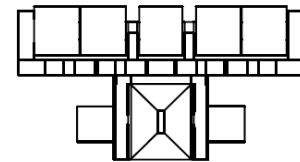
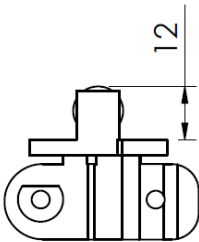

Flexible cleat chain 彈性鏈條

Chain	Link
FLTE 5B	FLTL 63B

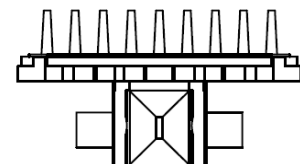
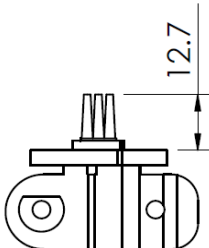

# FL

Pitch  
25.4mm

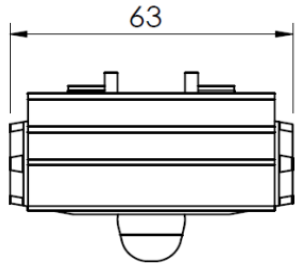
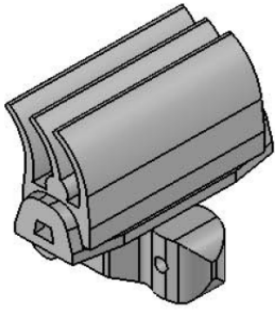

## Flexible cleat chain 彈性鏈條

Chain	Link
-------	------

FLTE 5C	FLTM 63C
---------	----------

Cleat top 彈性頂部	FLTX 55C
----------------	----------

Basic link 鏈條底座	FLTE 63D
-----------------	----------

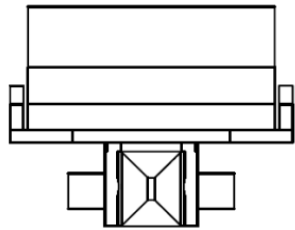
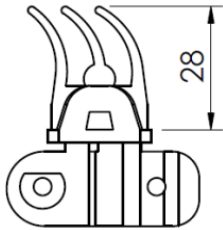

**F45**

**FT**

**FS**

**FL**

**F65**

**FM**

**F85**

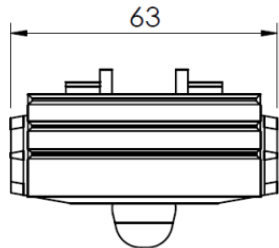
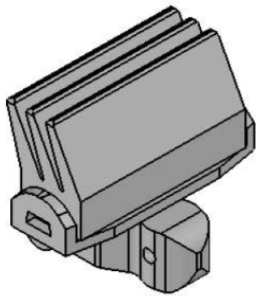

## Flexible cleat chain 彈性鏈條

Chain	Link
-------	------

FLTE 5CA	FLTM 63CA
----------	-----------

Cleat top 彈性頂部	FLTX 55CA
----------------	-----------

Basic link 鏈條底座	FLTE 63D
-----------------	----------

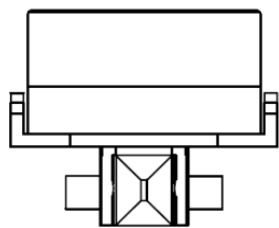
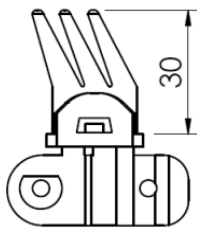

**FH**

**FK**

**FB**

**Spiral**

**FW**

**IDX**

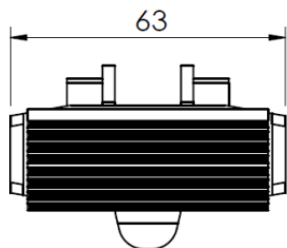
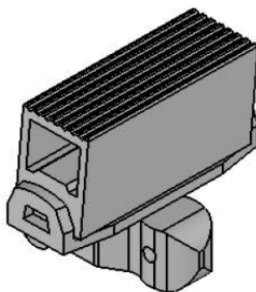

## Flexible cleat chain 彈性鏈條

Chain	Link
-------	------

FLTE 5D	FLTM 63D
---------	----------

Cleat top 彈性頂部	FLTX 55D
----------------	----------

Basic link 鏈條底座	FLTE 63D
-----------------	----------

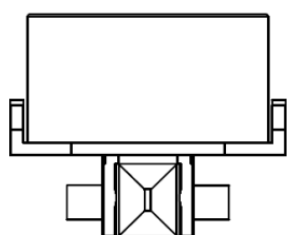
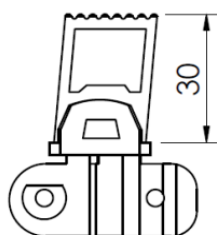

# FL

Pitch  
25.4mm

F45  
FT  
FS  
**FL**

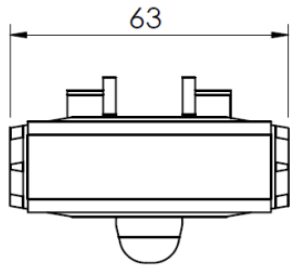
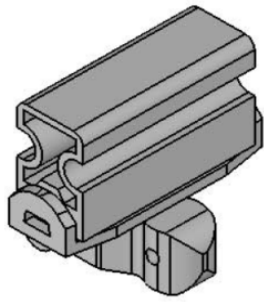

Flexible cleat chain 彈性鏈條

Chain	Link
-------	------

FLTE 5DA	FLTM 63DA
----------	-----------

Cleat top 彈性頂部	FLT X 55DA
----------------	------------

Basic link 鏈條底座	FLTE 63D
-----------------	----------

F65  
FM  
F85

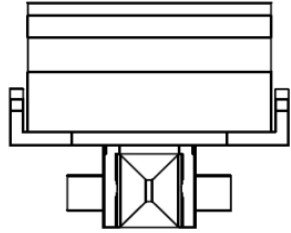
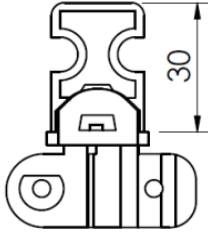

FH  
FK  
FB  
Spiral  
FW  
IDX

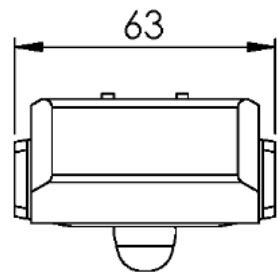
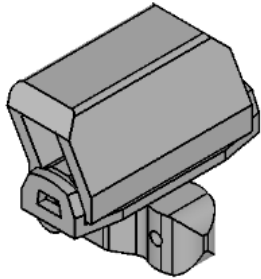

Flexible cleat chain 彈性鏈條

Chain	Link
-------	------

FLTE 5DB	FLTM 63DB
----------	-----------

Cleat top 彈性頂部	FLT X 55DB
----------------	------------

Basic link 鏈條底座	FLTE 63D
-----------------	----------

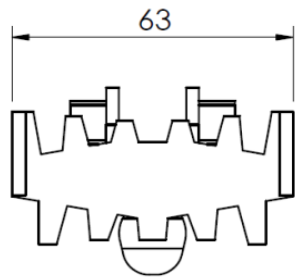
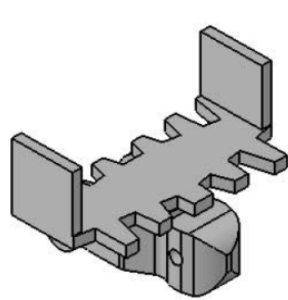
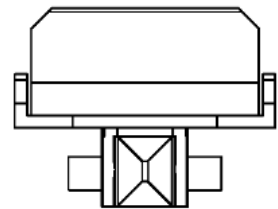
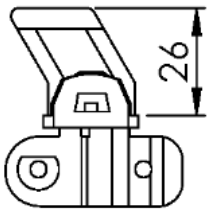

Chain w/ elevated edges

側邊檔板鏈條

Chain	Link
-------	------

63TLW	n.a.
-------	------

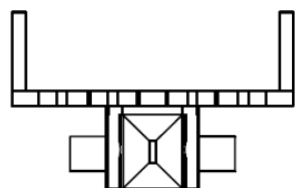
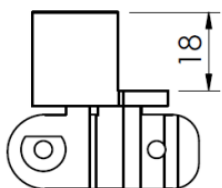

# FL

Pitch  
25.4mm

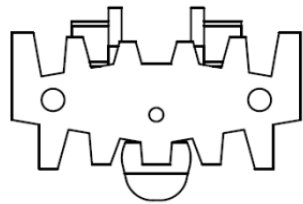
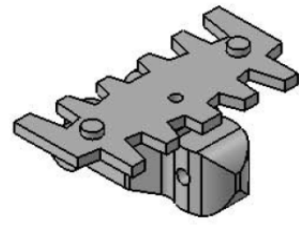

## Universal chain 多功能鏈條

Chain	Link
FLTF 5U	FLTL 63U

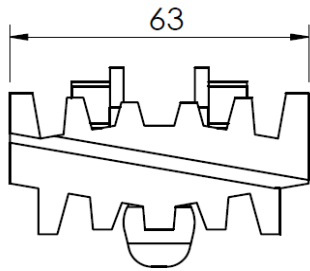
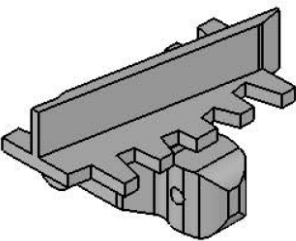
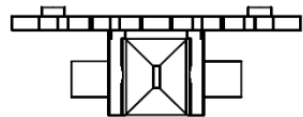
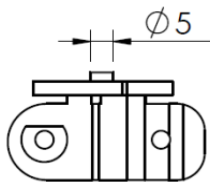

## Cleated chain 檔板鏈條

Chain	Link
F3924165	F3905959

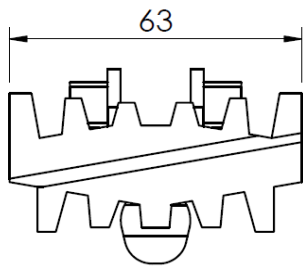
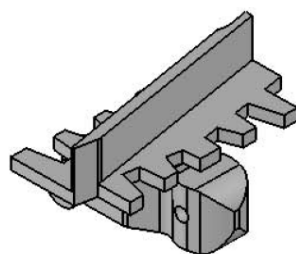
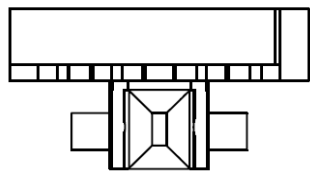
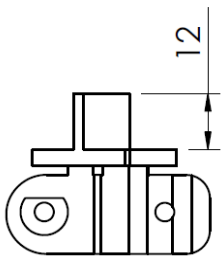

## Cleated chain 檔板鏈條

Chain	Link
F3924166	F3902427

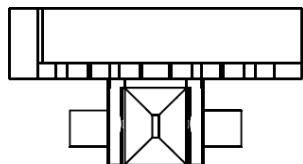
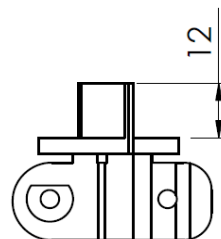

- F45**
- FT**
- FS**
- FL**
- F65**
- FM**
- F85**
- FH**
- FK**
- FB**
- Spiral
- FW**
- IDX**

# FL

Pitch  
25.4mm

F45

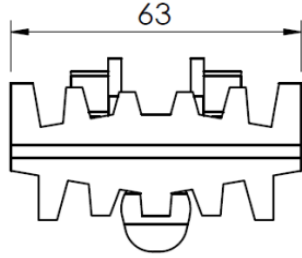
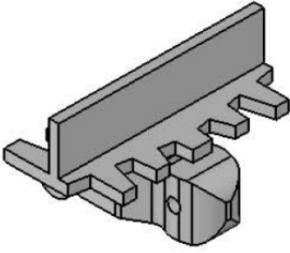

Cleated chain 檔板鏈條

FT

FS

**FL**

F65

FM

F85

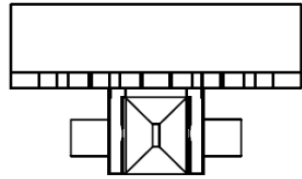
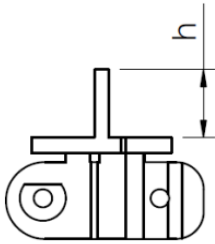

Chain	Link	DIM.
F3924568	F3924567	h=15
F5046426	F5046425	h=30

FH

FK

FB

Spiral

FW

IDX

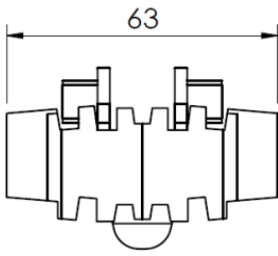
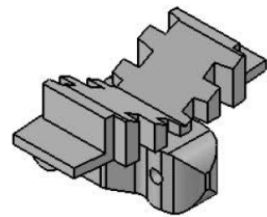

Cleated chain 檔板鏈條

Chain	Link
F3924168	F3904675
V-block	

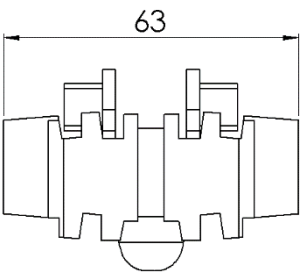
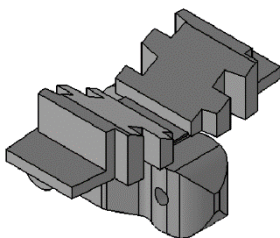
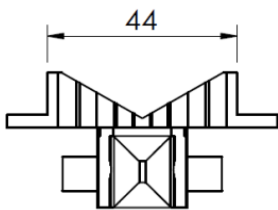
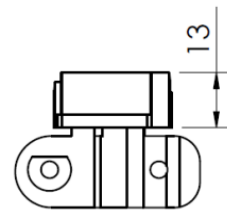

Cleated chain 檔板鏈條

Chain	Link
F3905520	F3905522
V-block	

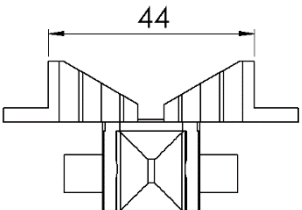
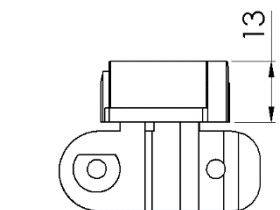



FL

Pitch  
25.4mm

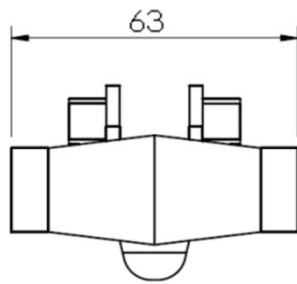
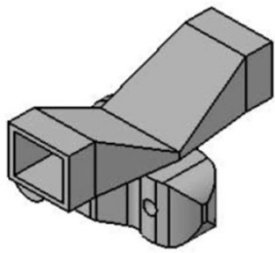

Cleated chain 檔板鏈條

Chain	Link
-------	------

F3921955A	F3921643A
-----------	-----------

V-block

F45

FT

FS

**FL**

F65

FM

F85

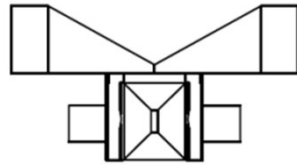
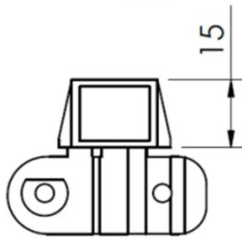

FH

FK

FB

Spiral

FW

IDX

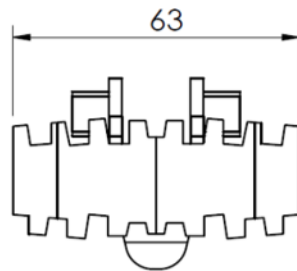
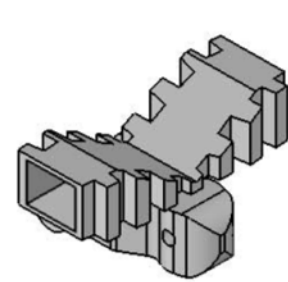

Cleated chain 檔板鏈條

Chain	Link
-------	------

F3921955-120deg	F3921643-120deg
-----------------	-----------------

V-block

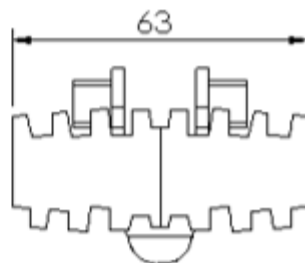
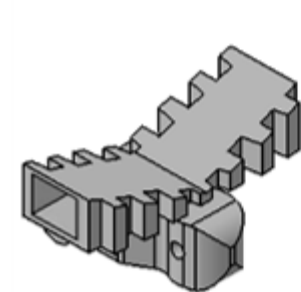
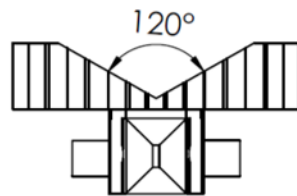
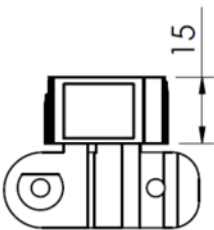

Cleated chain 檔板鏈條

Chain	Link
-------	------

F3921955-140deg	F3921643-140deg
-----------------	-----------------

V-block

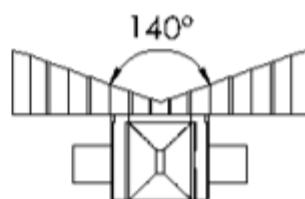
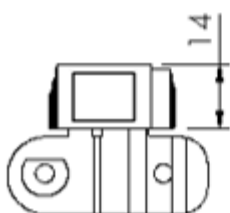

# FL

Pitch  
25.4mm

F45

FT

FS

**FL**

F65

FM

F85

FH

FK

FB

Spiral

FW

IDX

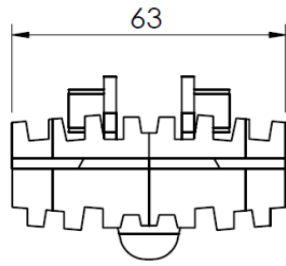
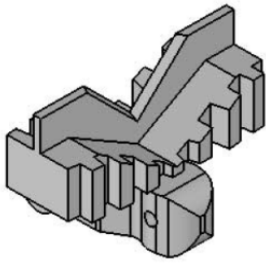

Cleated chain 檔板鏈條

Chain	Link
F3921009	F3921647

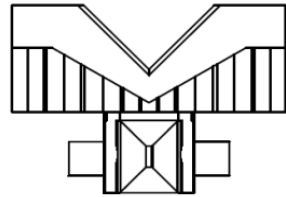
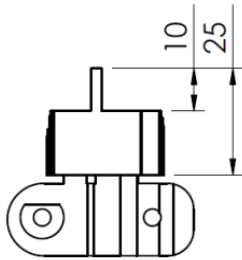

FH

FK

FB

Spiral

FW

IDX

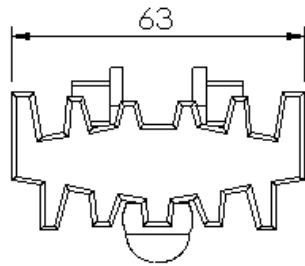
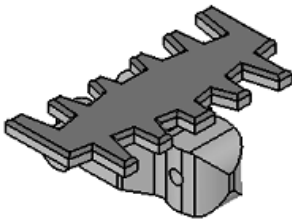

Flocked chain 植絨鏈條

Chain	Link
F5047490	n.a.

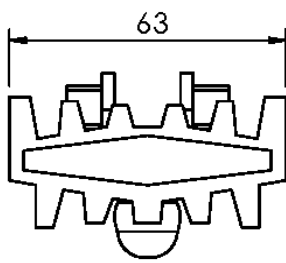
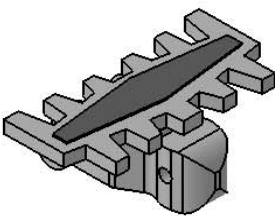
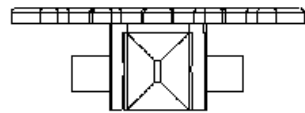
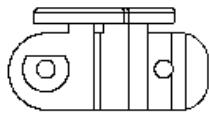

Friction top chain 阻滑鏈條

Chain	Link
F5052817	F5052822

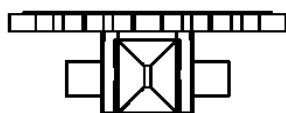
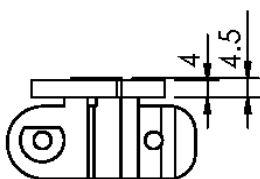

FL

Pitch  
25.4mm

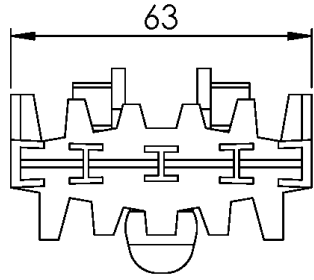
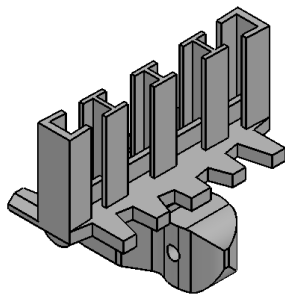

Cleated chain 檔板鏈條

Chain	Link
F3905563	F3905562

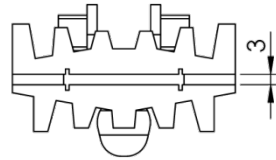
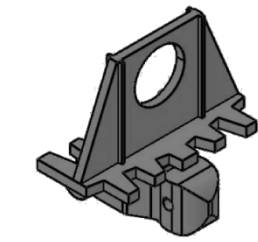
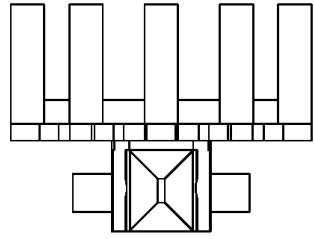
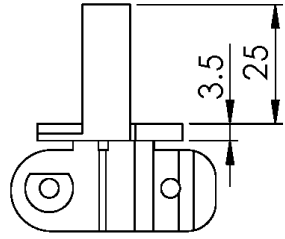

Cleated chain 檔板鏈條

Chain	Link
F5048590	n.a.
n.a.	F5048588
n.a.	F5048589

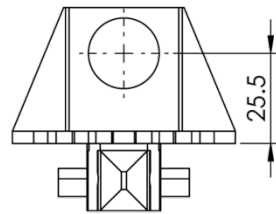
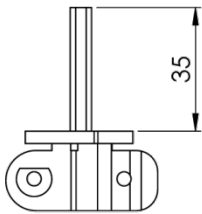

F5048588

transportation of golf balls  
高爾夫球運輸

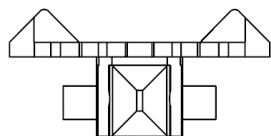
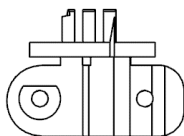
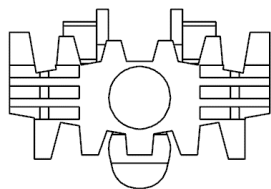
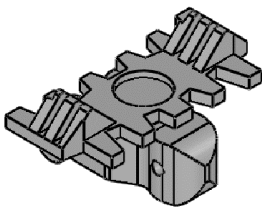

F5048589

- F45
- FT
- FS
- FL**
- F65
- FM
- F85
- FH
- FK
- FB
- Spiral
- FW
- IDX

# FL

Pitch  
25.4mm

- F45
- FT
- FS
- FL**
- F65
- FM
- F85
- FH
- FK
- FB
- Spiral
- FW
- IDX

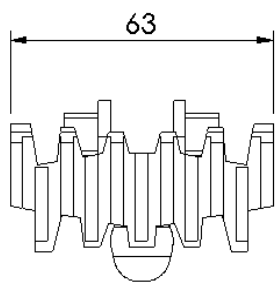
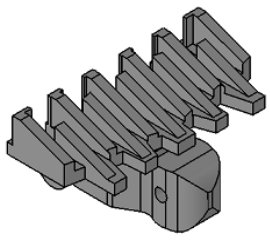

Cleated chain 檔板鏈條

Chain	Link
F3924167	F3903648

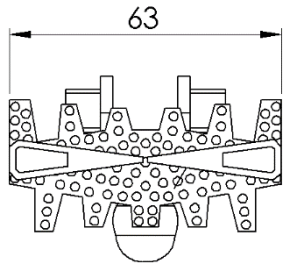
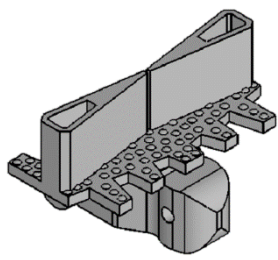
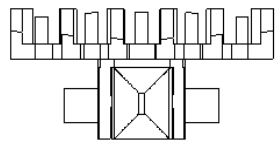
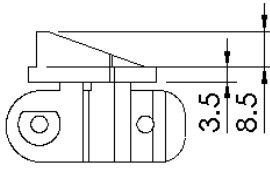

Cleated chain w/ non-stick surface  
防黏檔板鏈條

Chain	Link
F5058493	F5058514

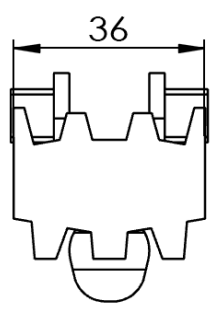
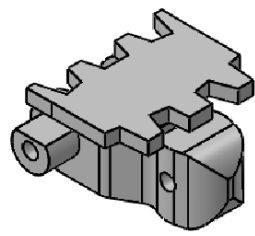
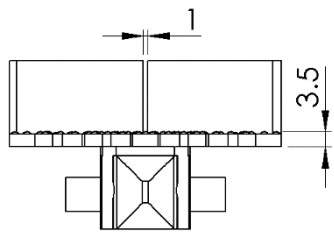
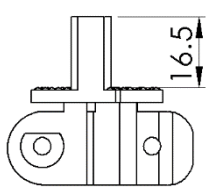

Plain chain, width 36 mm  
平面鏈條, 寬 36 mm

Chain	Link
F3925989 PBT	F3925988

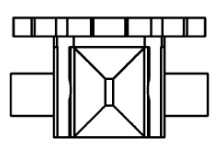
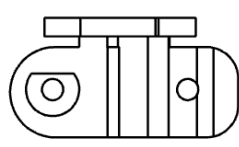

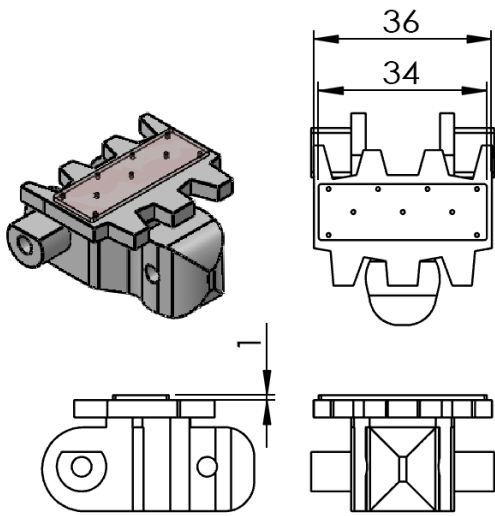

Friction top chain 阻滑鏈條

Chain	Link
FL36F	n.a.

F45

FT

FS

**FL**

F65

FM

F85

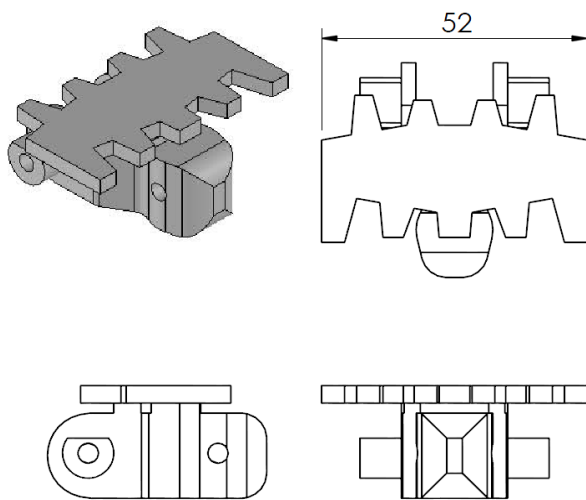

Plain chain, width 52 mm  
平面鏈條, 寬 52 mm

Chain	Link
ONR895 PBT	n.a.

FH

FK

FB

Spiral

FW

IDX

Transport of cigarette  
香菸運輸

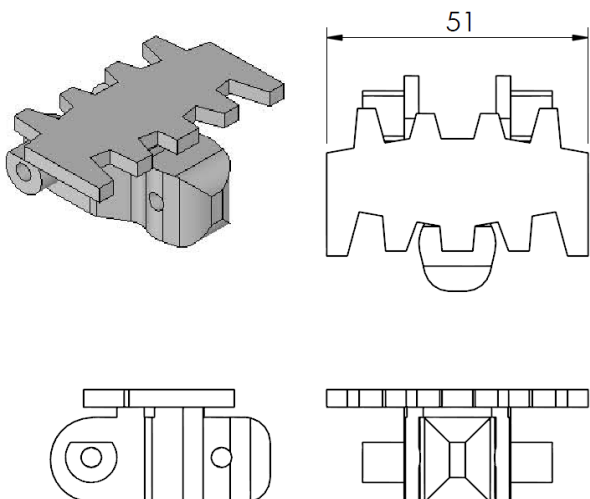

Plain chain, width 51 mm  
平面鏈條, 寬 51 mm

Chain	Link
F3905570 PBT	F3905569

Transport of cigarette  
香菸運輸

# FL

Pitch  
25.4mm

F45  
FT  
FS  
**FL**

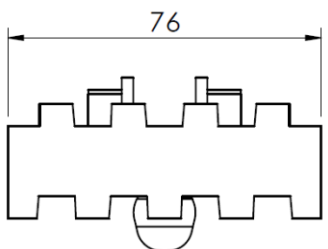
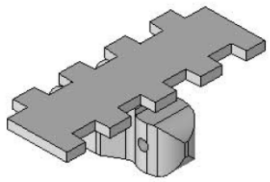

Plain chain, width 76 mm  
平面鏈條, 寬 76 mm

Chain	Link
F3924474	F3924475
PBT	

F65  
FM  
F85

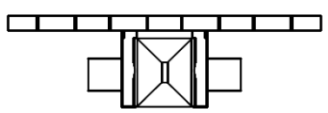
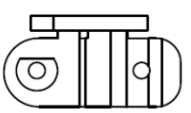

Transport of cigarette  
香菸運輸

FH  
FK  
FB  
Spiral  
FW  
IDX

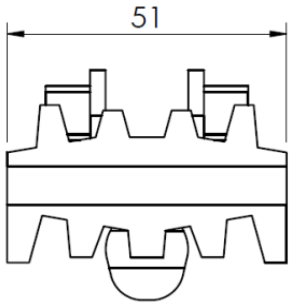
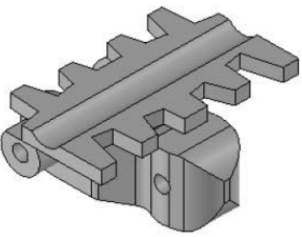

Cleated chain 檔板鏈條

Chain	Link
F3924441	F3904649
POM	
F3921533	F3921532
PBT	

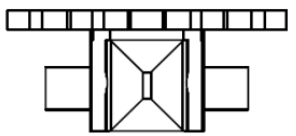
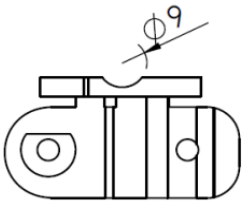

Transport of cigarette  
香菸運輸

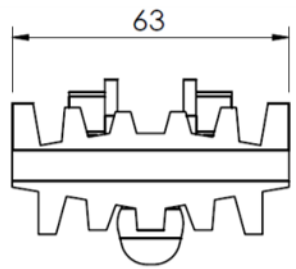
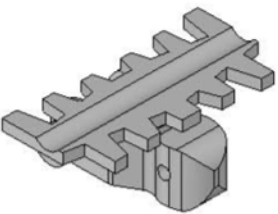

Cleated chain 檔板鏈條

Chain	Link	DIM.
F3924442	F3904648	d=9
F3924442B	F3904648B	d=6.3
POM		

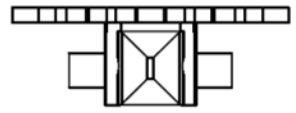
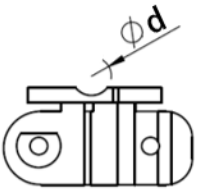

Transport of cigarette  
香菸運輸

FL

Pitch  
25.4mm

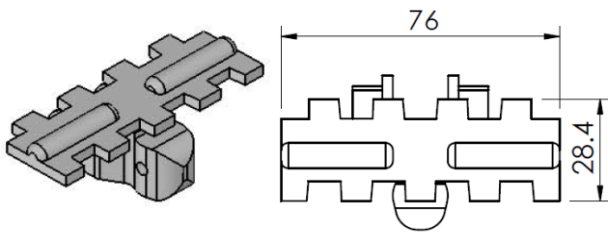

Cleated chain 檔板鏈條

Chain	Link
OCD7403	n.a.
PBT	

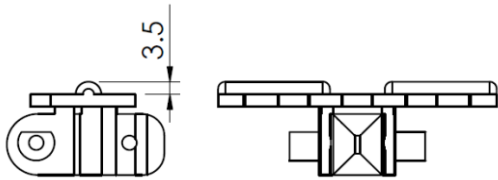

Transport of cigarette  
香菸運輸

F45

FT

FS

**FL**

F65

FM

F85

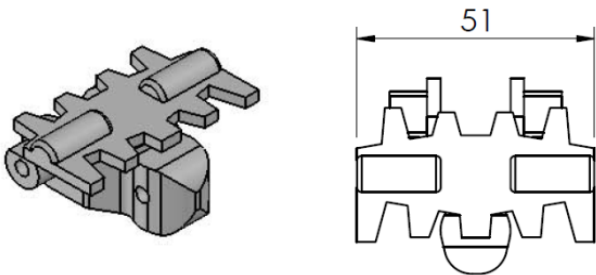

Cleated chain 檔板鏈條

Chain	Link
F3924156	F3902429
POM	
F3905225	F3905784
PBT	

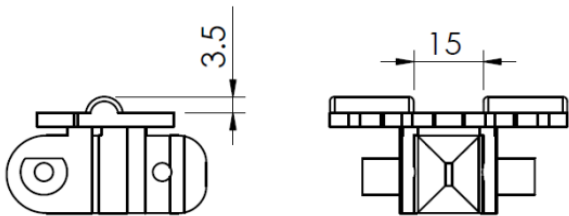

Transport of cigarette  
香菸運輸

FH

FK

FB

Spiral

FW

IDX

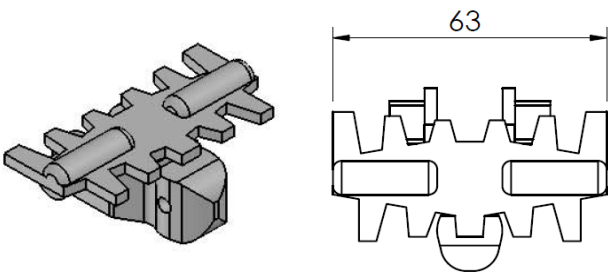

Cleated chain 檔板鏈條

Chain	Link
F3924157	F3902428
POM	
F3905380	F3905379
PBT	

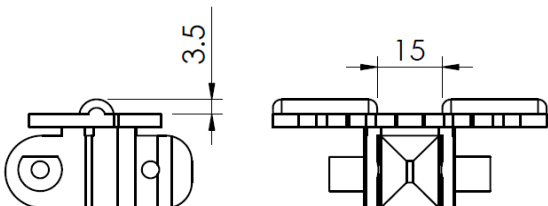

Transport of cigarette  
香菸運輸

# FL

Pitch  
25.4mm

F45  
FT  
FS  
**FL**

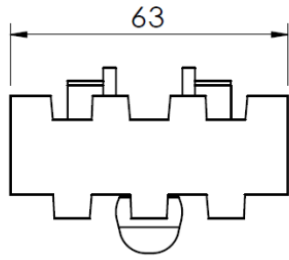
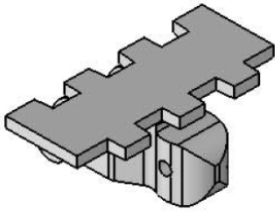

Plain chain 平面鏈條

Chain	Link
F5112949	F5112948
POM	
F5112949B	F5112948B
PBT	

F65  
FM  
F85

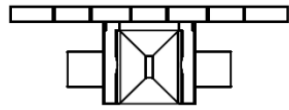
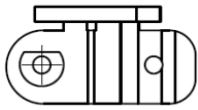

Transport of cigarette  
香菸運輸

FH  
FK  
FB  
Spiral  
FW  
IDX

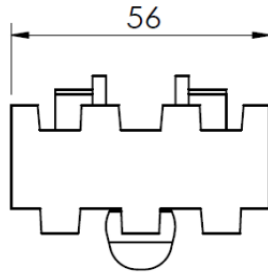
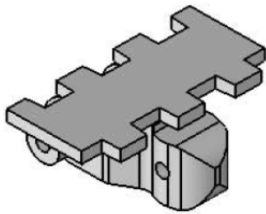

Plain chain, width 56 mm  
平面鏈條, 寬 56 mm

Chain	Link
F3903453	F3903452
POM	
F3904561	F3904549
PBT	

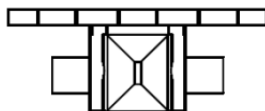
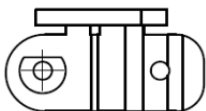

Transport of cigarette  
香菸運輸

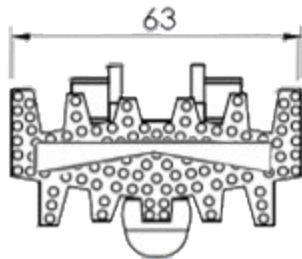
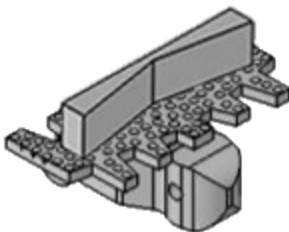

Cleated chain w/ non-stick surface  
防黏檔板鏈條

Chain	Link	DIM.
F5058306H16	F5058304H16	H=16.5

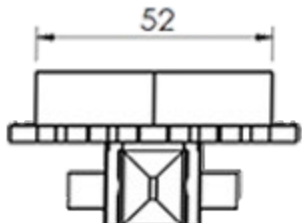
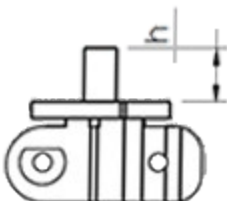



FL

Pitch  
25.4mm

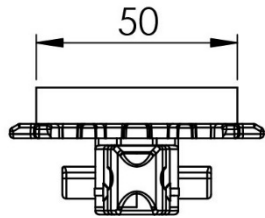
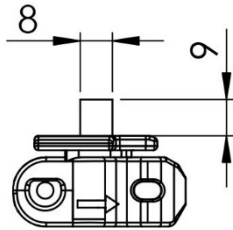
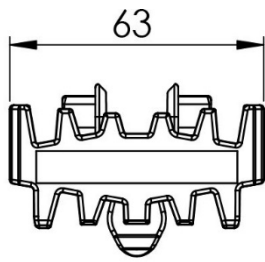
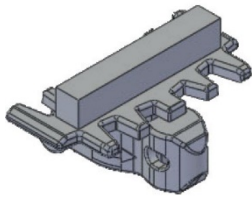

Cleated chain 檔板鏈條

Chain	Link
FLTF 5X9D	FLTL 63X9D

F45

FT

FS

**FL**

F65

FM

F85

FH

FK

FB

Spiral

FW

IDX